

begane grond

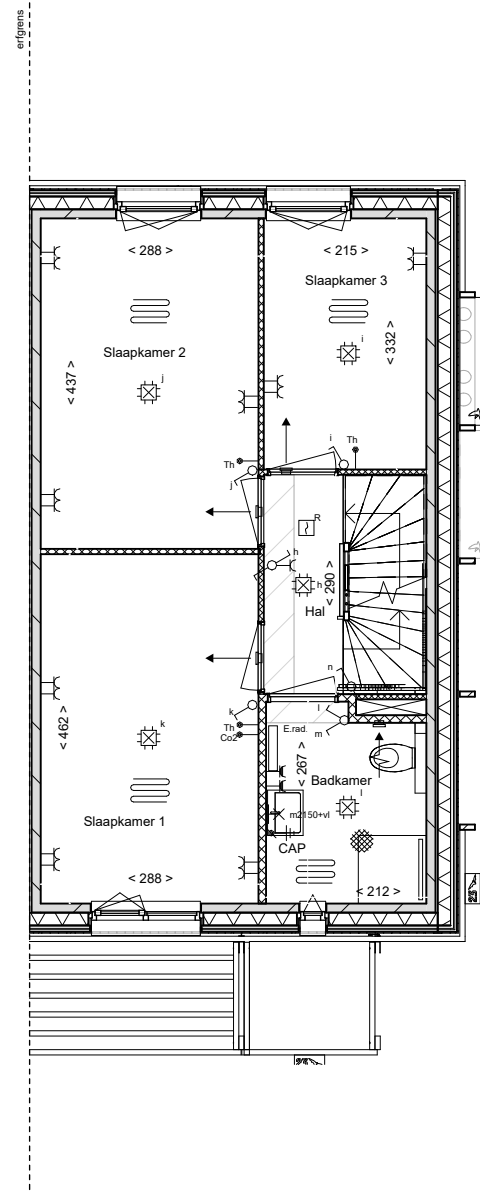

eerste verdieping

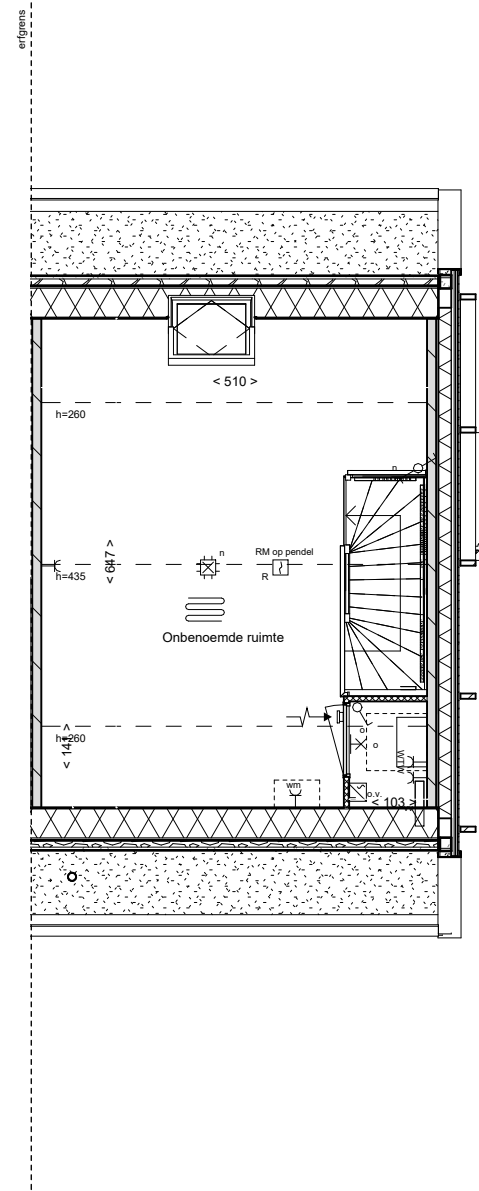

zolder

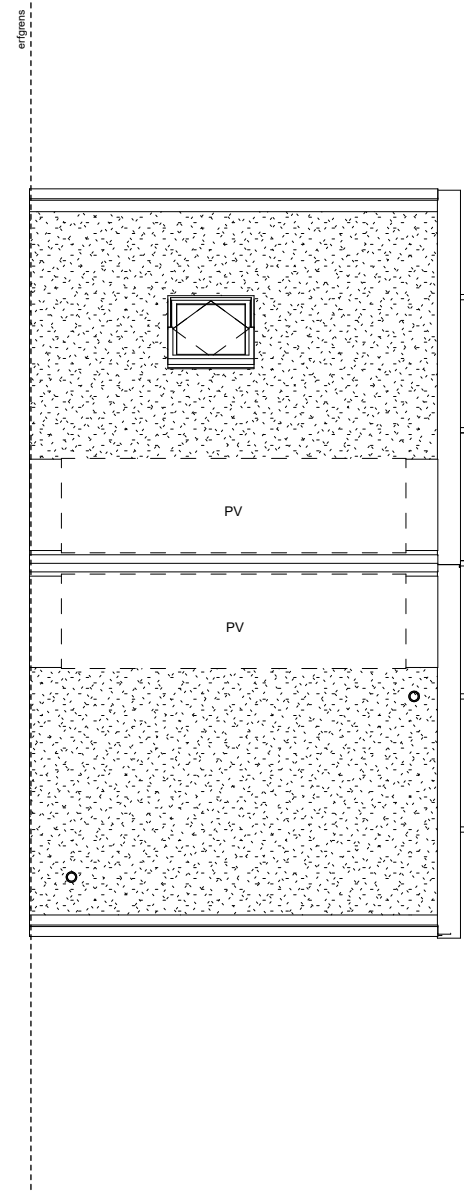

dakaanzicht

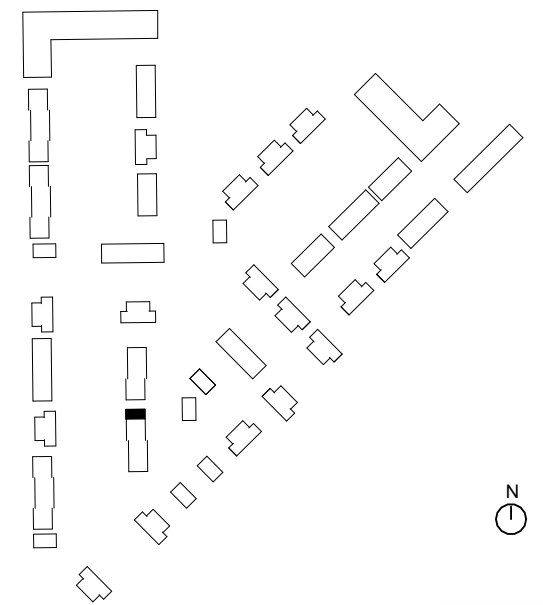

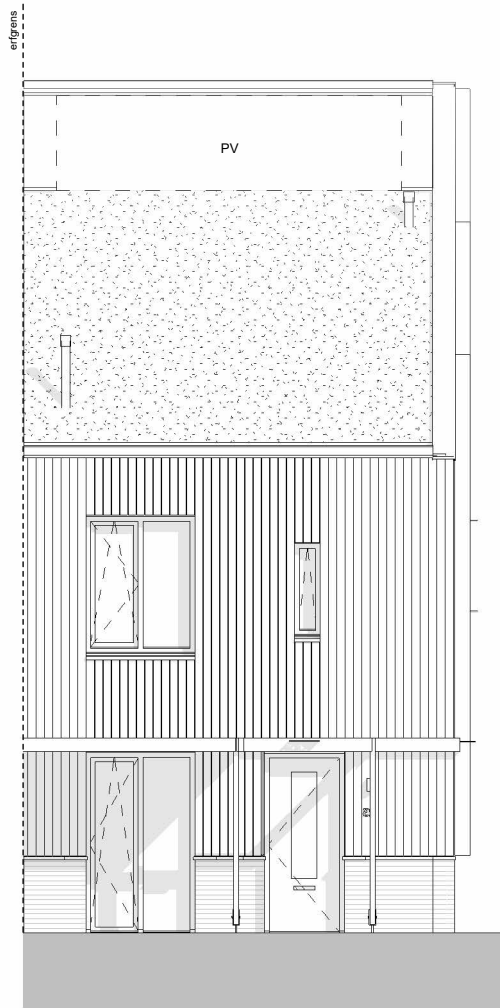

voorgevel

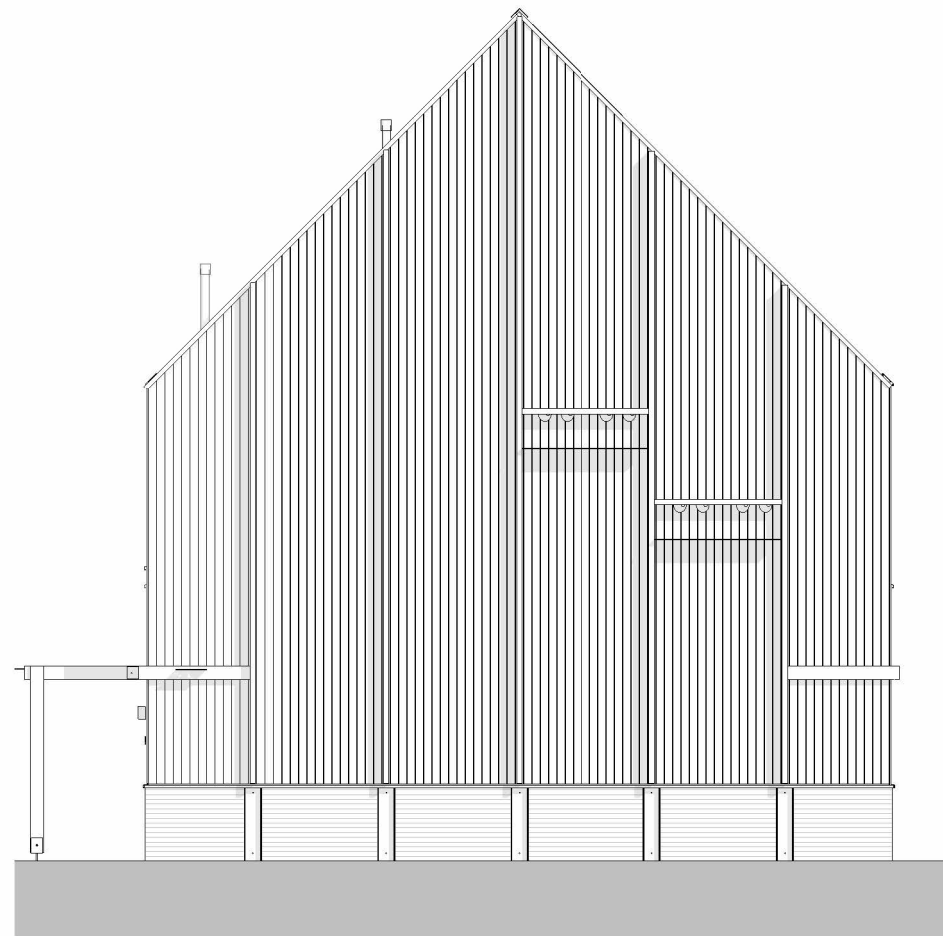

kopgevel met zwaluwnesten

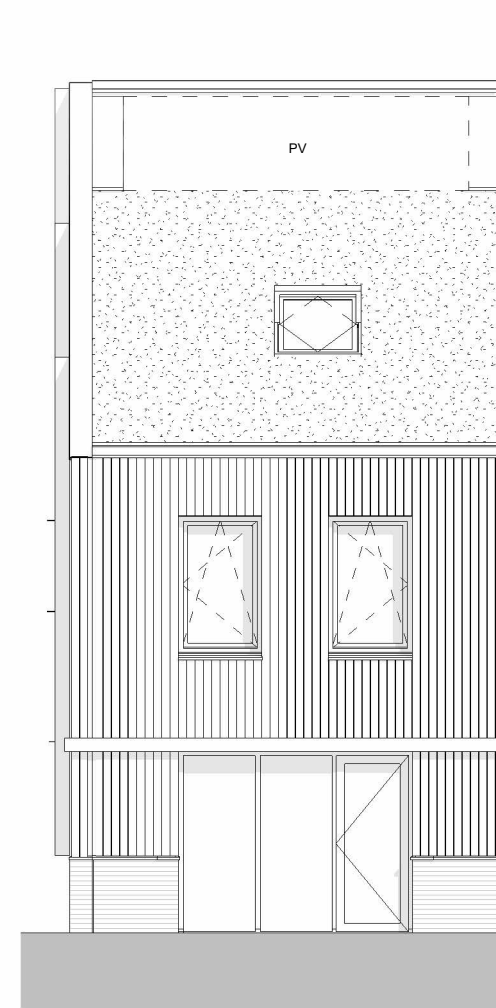

achtergevel

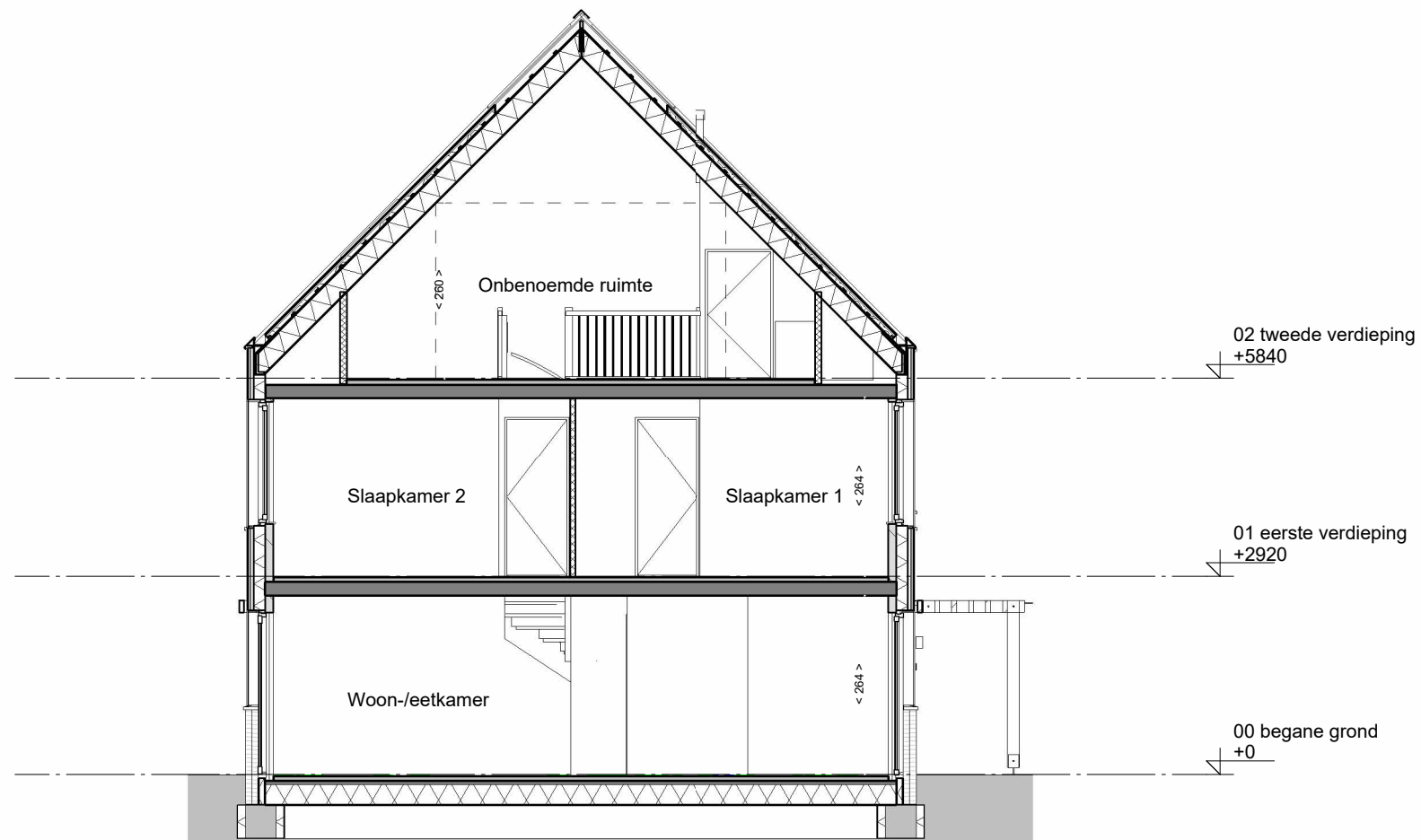

doorsnede

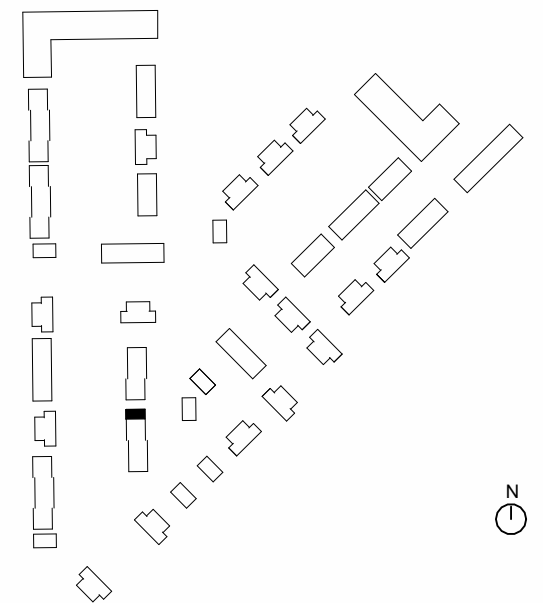

Omschrijving
Gevelaanzichten en doorsneden voorlopig

Onderdeel Verkooptekening	tekeningnummer VK-075-2	getekend	schaal	formaat
Bouwnummer(s) 75	-	-	1 : 100	A3

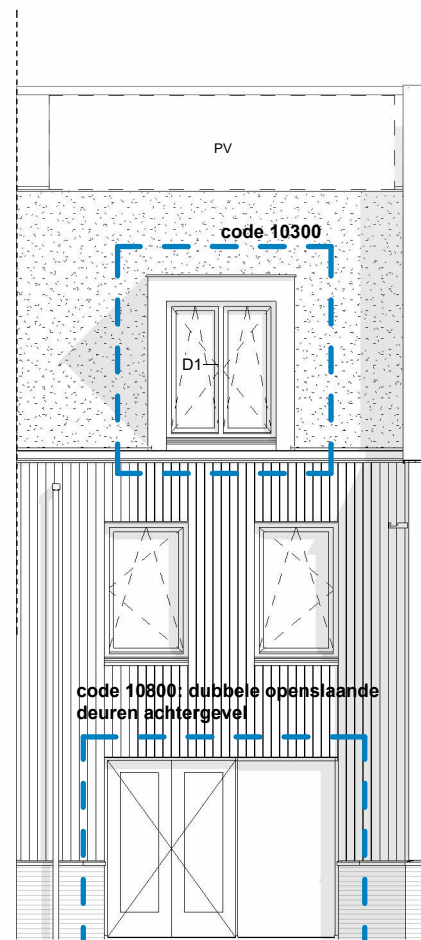

achtergevel

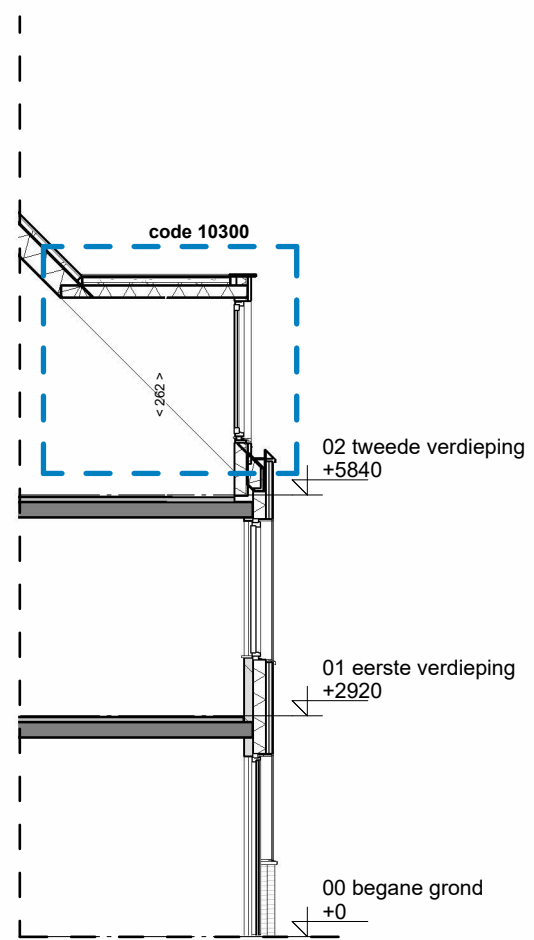

doorsnede

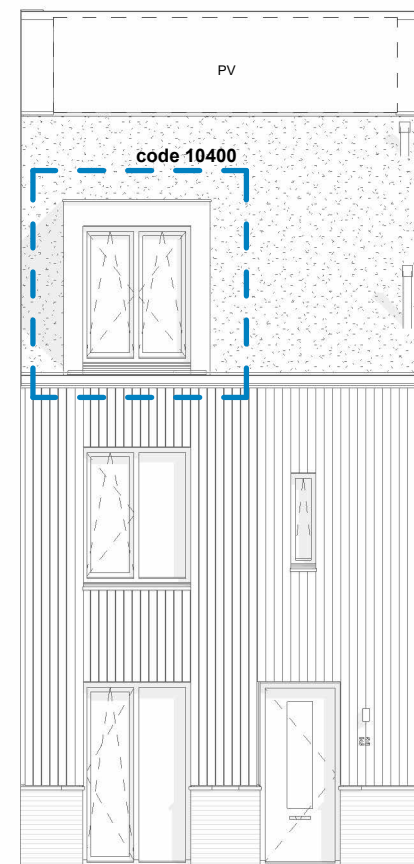

voorgevel

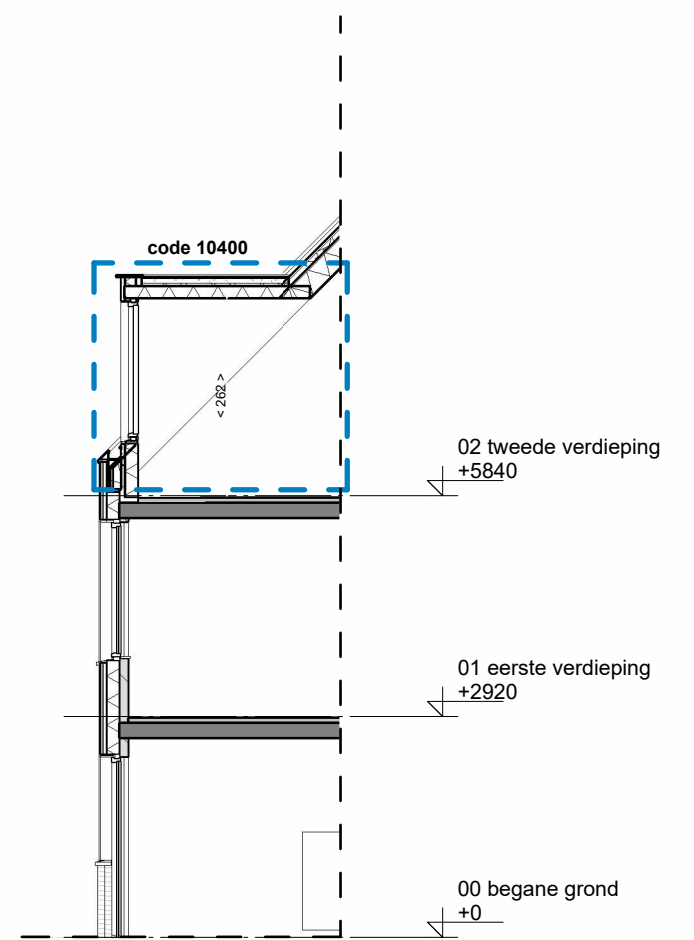

doorsnede

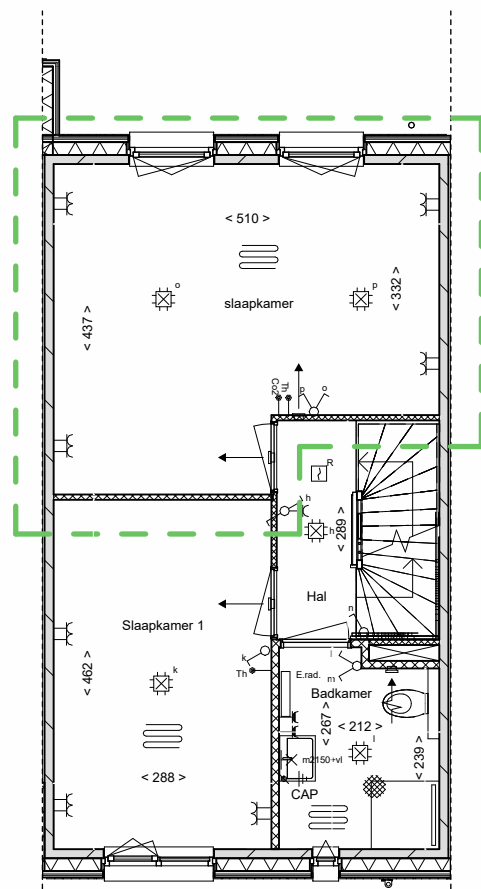

eerste verdieping

code 12100: slaapkamers samenvoegen

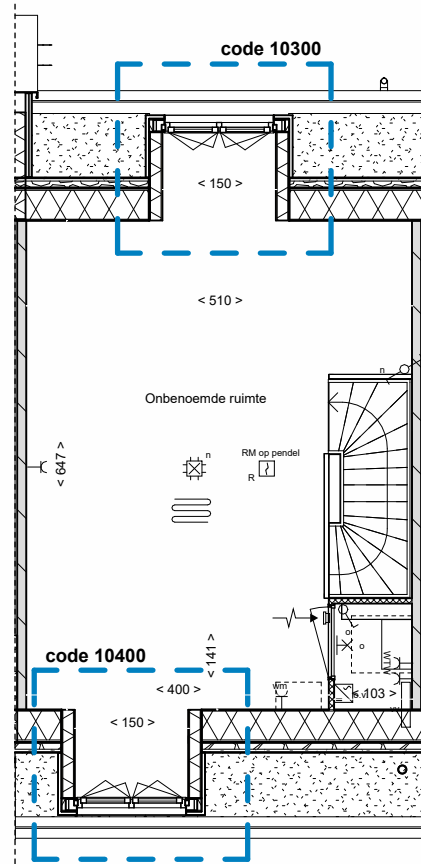

tweede verdieping

code 10300: dakkapel achtergevel
code 10400: dakkapel voorgevel

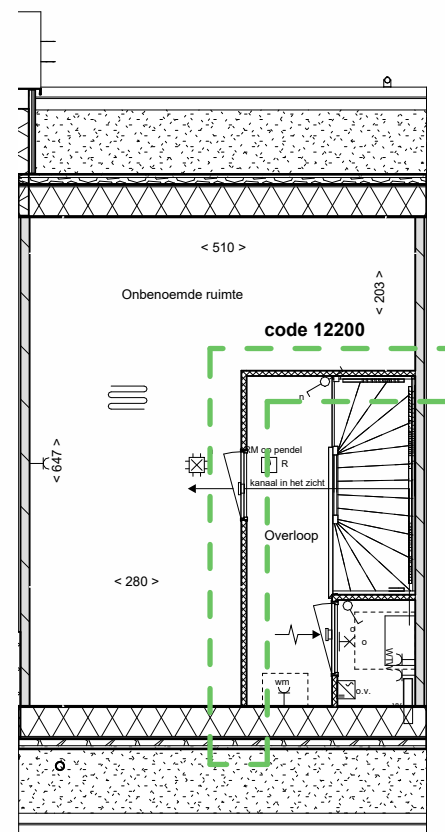

tweede verdieping

code 12200: zolderindeling

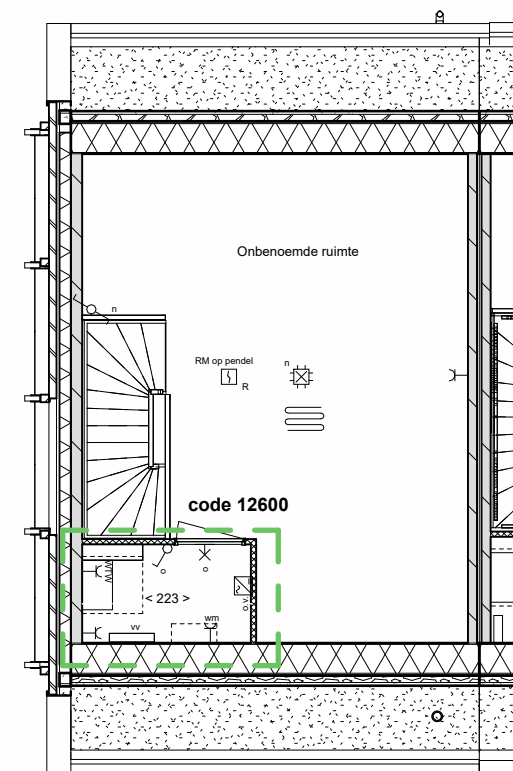

tweede verdieping

code 12600: grote technische ruimte

NB:
Kopersopties slechts ter indicatie van de extra ruimte en bijbehorende gevelopeningen; materialisatie van de gevel (hout of metselwerk, veranda of luifel) wijkt mogelijk af van uw bouwnummer.

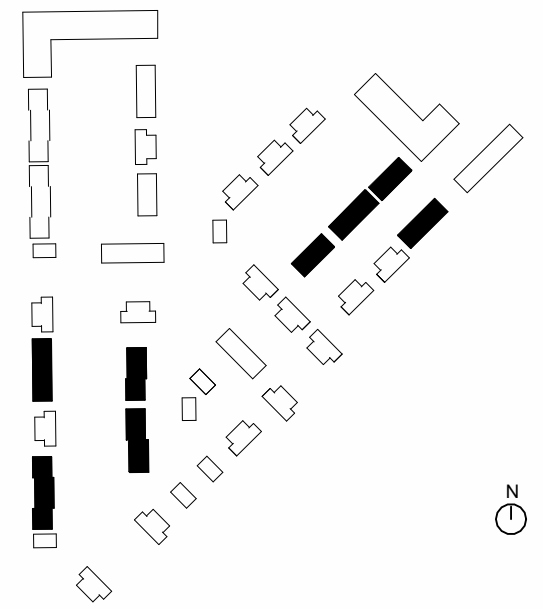

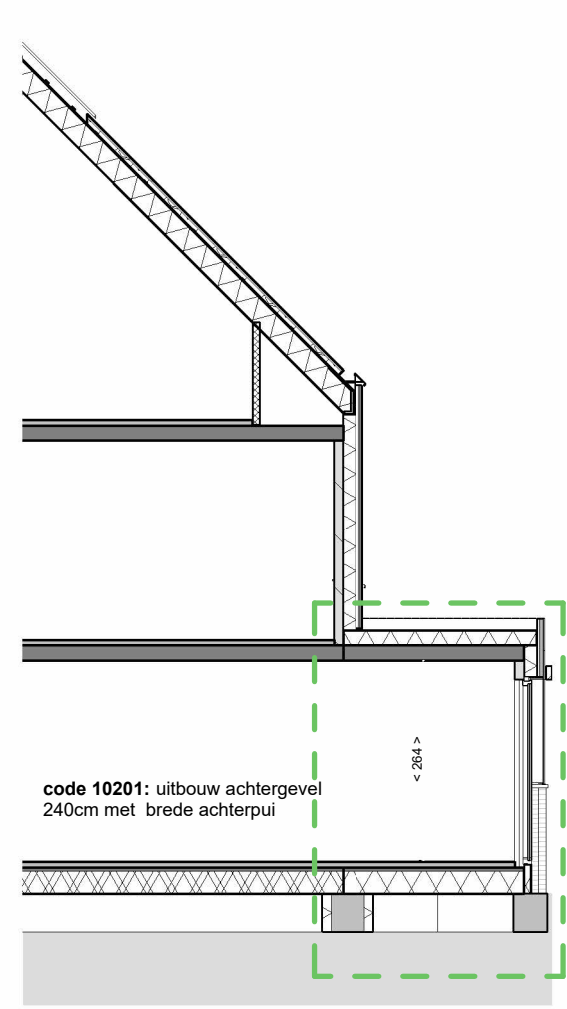
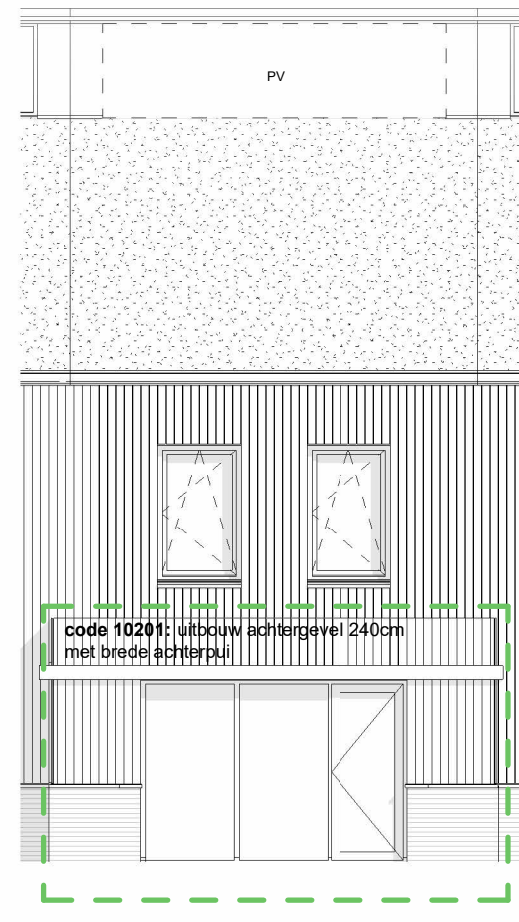
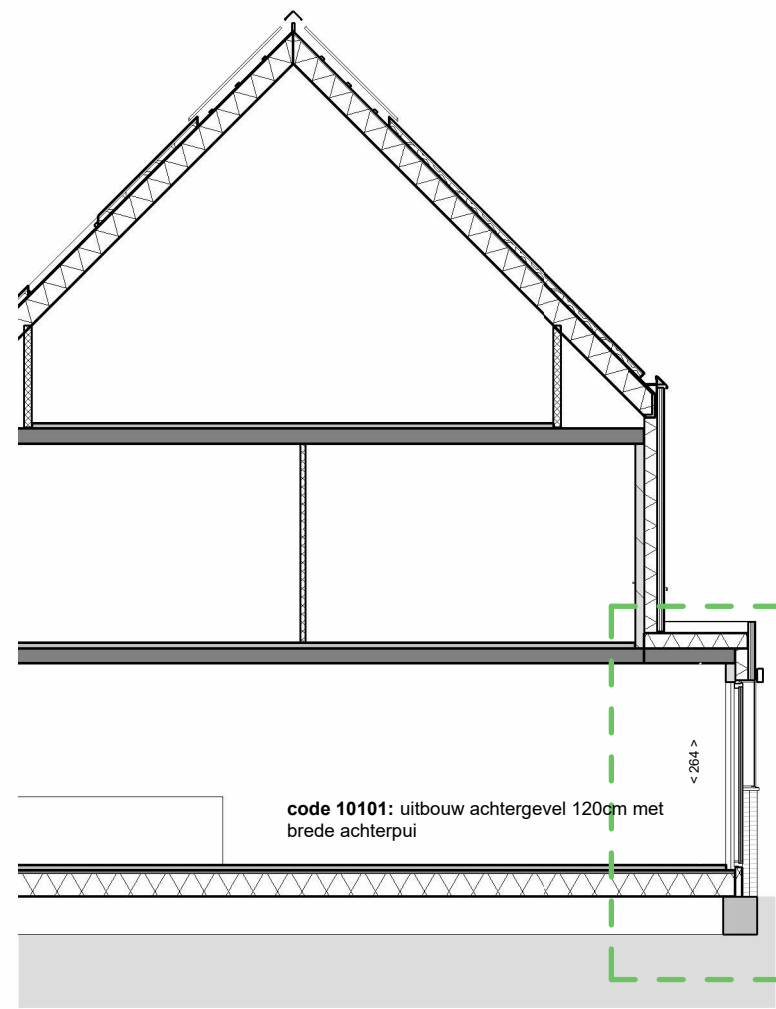
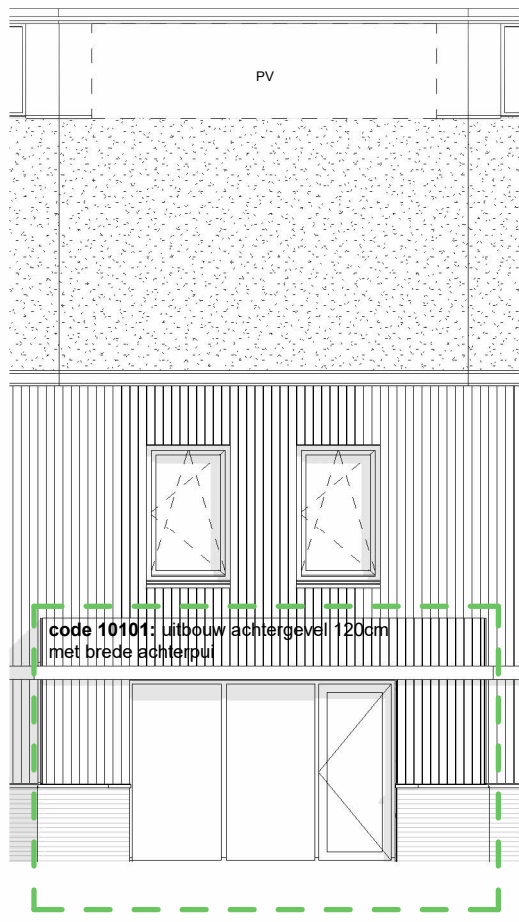

achtergevel

doorsnede

achtergevel

doorsnede

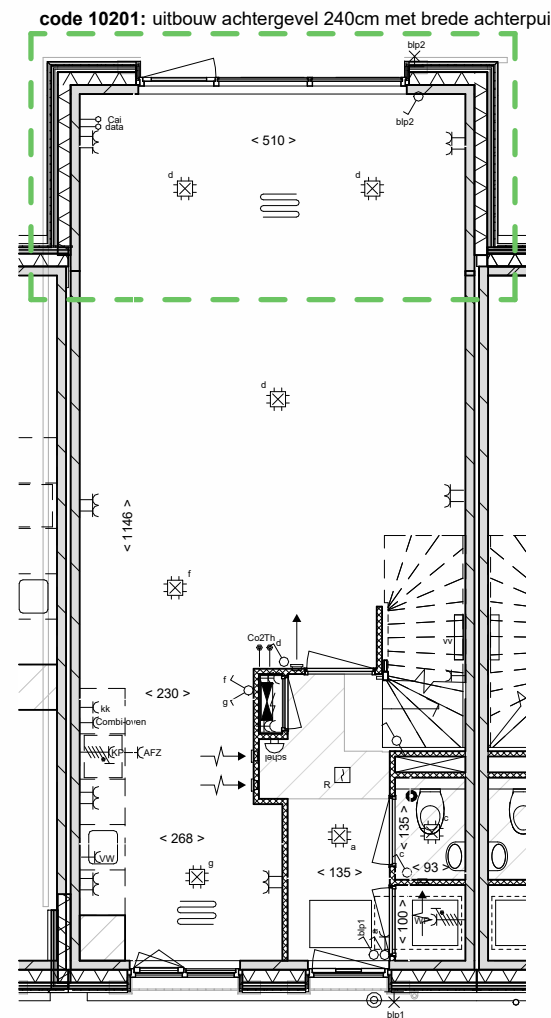
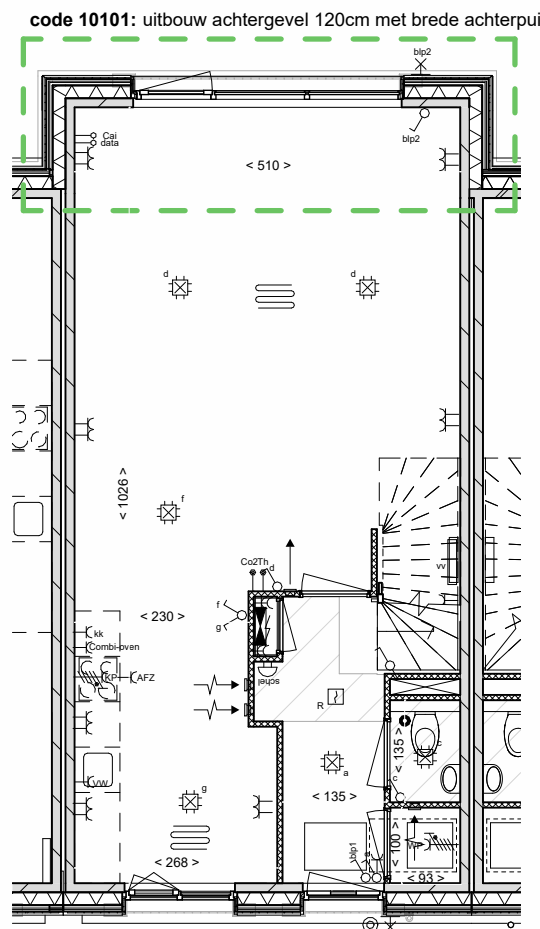

begane grond

begane grond

